

UltraDish™ TP 400

DIRECTIONAL PARABOLIC DISH ANTENNA WITH TWISTPORT™ CONNECTOR

UltraDish™ TP 400's are designed for CPE or PtP connections. The antenna reflector is made from an aluminum alloy to ensure a very uniform shape. Our virtually lossless TwistPort™ connector guarantees easy radio deployment and maintenance.

Antenna installation is extremely easy and ensures rapid deployment for large scale projects. Our innovative antenna mount fits a wide range of pole diameters and can be easily swapped for right or left side mounts. A single HEX tool is all you need to perform your installation.

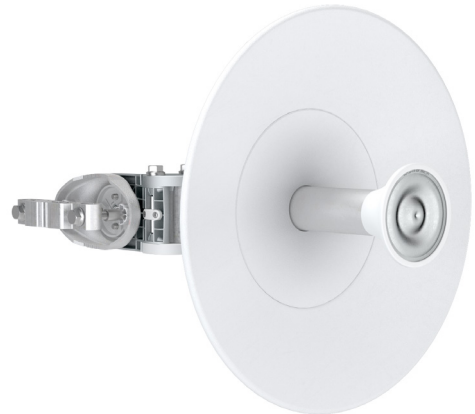

Gain H

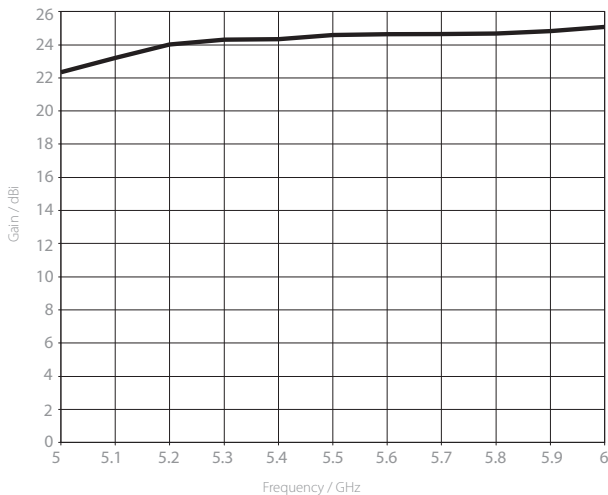

Azimuth Pattern H

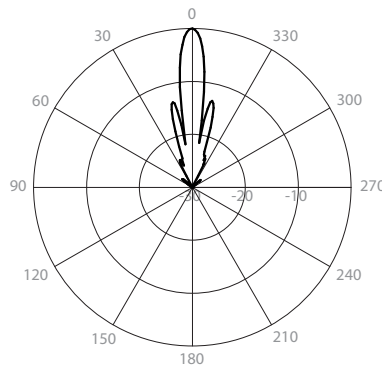

Elevation Pattern H

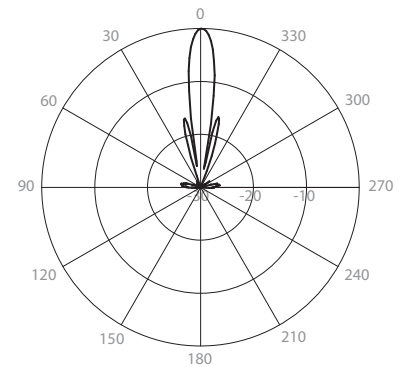

Gain V

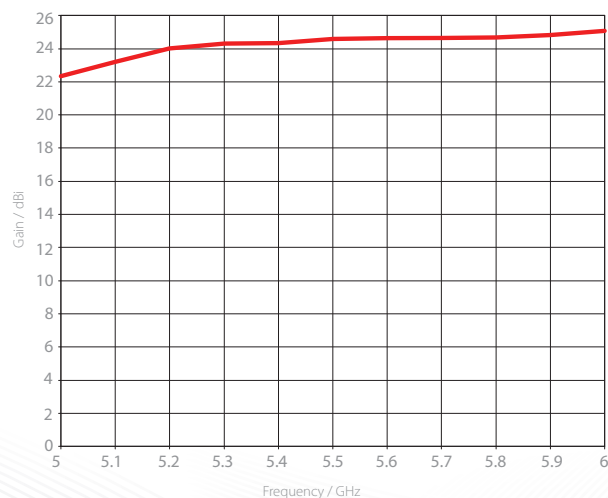

Azimuth Pattern V

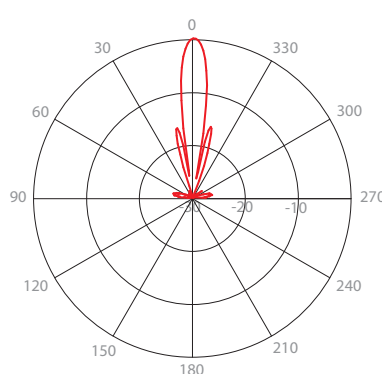

Elevation Pattern V

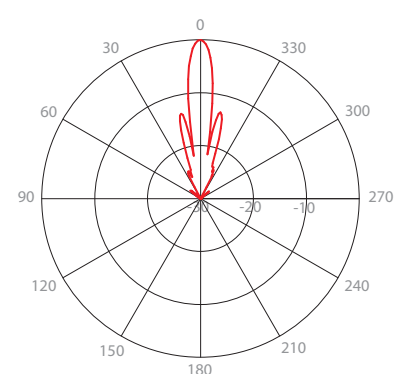

PHYSICAL

Antenna Connection	TwistPort™ - Quick Locking Waveguide Port
Antenna Type	Parabolic Dish
Environmental	IP65
Pole Mounting Diameter	22-80 mm
Temperature	-40 to +60 °C (-40°F to +140°F)
Wind Survival	160 Km/h
Weight	2.7 Kg / 6 lbs – single unit (one antenna) 14 Kg / 31 lbs – 4PACK (4 units) incl. package
Dimensions	Retail Box 4PACK: 45 x 45 x 39 cm

PERFORMANCE

Gain	24.5 dBi
Azimuth Beam Width -6 dB	H 11° / V 11°
Elevation Beam Width -6 dB	H 11° / V 11°
Azimuth Beam Width -3 dB	H 7° / V 7°
Elevation Beam Width -3 dB	H 7° / V 7°
Front-to-Back Ratio (Min)	35 dB

COMPATIBLE WIRELESS PLATFORMS

any TwistPort™ Adaptor

any SIMPER™ Radio

PRODUCT DIMENSIONS

